

FULL SWING QUILT PATTERN

Designed exclusively for **Fat Quarter Shop**
by **Rachel Griffith** (www.psq quilt.com)



66" x 66"



www.FatQuarterShop.com





FULL SWING QUILT PATTERN

Designed exclusively for Fat Quarter Shop
by Rachel Griffith (www.psiquilt.com)
Finished Size: 66" x 66"
www.FatQuarterShop.com

Note: Use 1/4" seams and press as arrows indicate throughout.

We do not recommend pre-washing the fabrics used in the Full Swing quilt pattern.

Cutting:

| Fabric | Quantity | Size | Swatch |
|---|----------|-------------------------|---|
| A | 136 | 3 1/2" x 3 1/2" squares |  |
| B | 32 | 5 7/8" x 5 7/8" squares | |
| | | | |
| C | 64 | 3 1/2" x 3 1/2" squares | from Charm Pack |
| | | | |
| D | 8 | 5 1/2" x 5 1/2" squares |  |
| E | 32 | 5 7/8" x 5 7/8" squares | |
| | | | |
| F* | 4 | 3 1/2" x WOF strips |  |
| G* | 2 | 3 1/2" x LOF strips | |
| *(see diagram on page 6 before cutting) | | | |
| | | | |
| Binding | 8 | 2 1/2" x WOF strips |  |

FULL SWING QUILT PATTERN

Designed exclusively for Fat Quarter Shop
by Rachel Griffith (www.psiquilt.com)
Finished Size: 66" x 66"
www.FatQuarterShop.com

Assembly:

25-Patch Block:

Sew seventeen 3 1/2" x 3 1/2" Fabric A squares and eight 3 1/2" x 3 1/2" Fabric C squares together as shown.

Block should measure 15 1/2" x 15 1/2".

Repeat seven more times.

Make eight blocks.

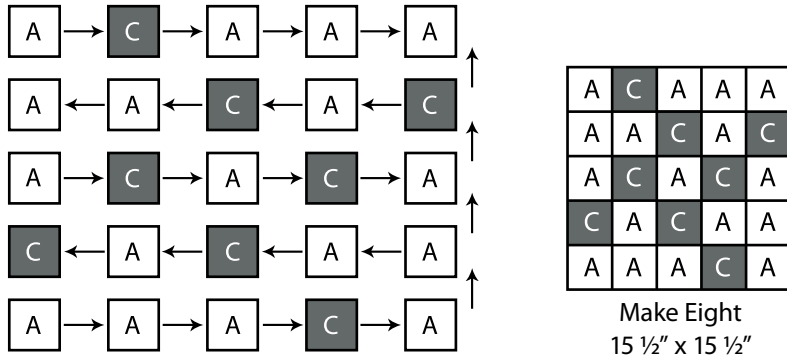

FULL SWING QUILT PATTERN

Designed exclusively for Fat Quarter Shop
by Rachel Griffith (www.psiquilt.com)
Finished Size: 66" x 66"
www.FatQuarterShop.com

Assembly:

Spinning Star Blocks:

Step One:

Draw a diagonal line on the wrong side of the 5 7/8" Fabric E squares.

With right sides facing, layer a 5 7/8" Fabric E square with a 5 7/8" Fabric B square.

Stitch 1/4" from each side of the drawn line.

Cut apart on marked line.

Half-square triangles should measure 5 1/2" x 5 1/2".

Repeat thirty-one more times.

Make sixty-four half-square triangles.

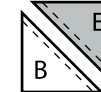

Make Sixty-four
5 1/2" x 5 1/2"

FULL SWING QUILT PATTERN

Designed exclusively for Fat Quarter Shop
by Rachel Griffith (www.psiquilt.com)
Finished Size: 66" x 66"
www.FatQuarterShop.com

Assembly:

Spinning Star Blocks:

Step Two:

Sew eight Fabric B/E half-square triangles and one 5 1/2" Fabric D square together as shown.

Pay attention to placement of fabrics.

Blocks should measure 15 1/2" x 15 1/2".

Repeat seven more times.

Make eight blocks.

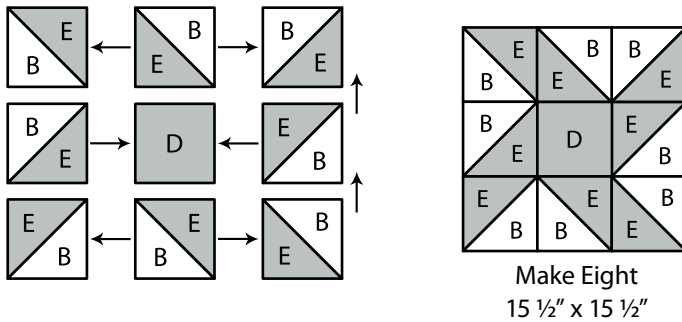

FULL SWING QUILT PATTERN

Designed exclusively for Fat Quarter Shop
by Rachel Griffith (www.psiquilt.com)
Finished Size: 66" x 66"
www.FatQuarterShop.com

Assembly:

Quilt Center Assembly:

Assemble blocks as shown.

Center unit should measure 60 1/2" x 60 1/2".

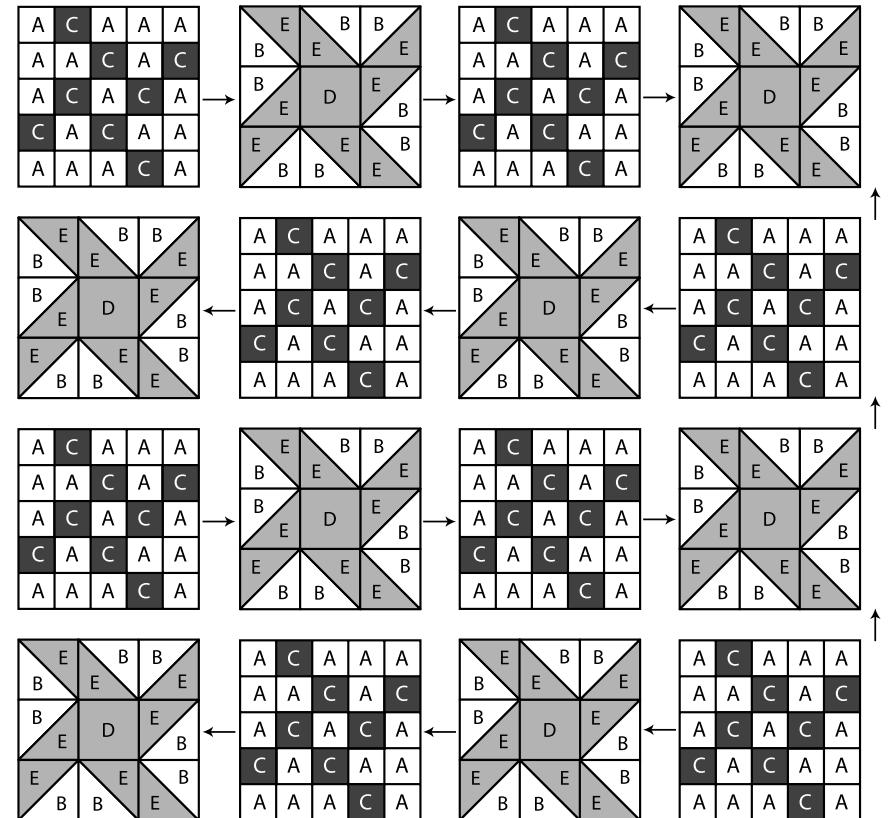

FULL SWING QUILT PATTERN

Designed exclusively for Fat Quarter Shop
by Rachel Griffith (www.psiquilt.com)
Finished Size: 66" x 66"
www.FatQuarterShop.com

Assembly:

Borders: (See diagram on page 7 before cutting.)

First cut four 3 1/2" x WOF (width of fabric) Fabric F strips for top and bottom borders.

Then cut two 3 1/2" x LOF (length of fabric) Fabric G strips for side borders. You must cut across the length, not the width, since this fabric is directional.

.....
Sew all four Fabric F strips together end to end, piecing diagonally.

.....
Subcut Fabric F into two 3 1/2" x 66 1/2" strips for the top and bottom borders.

Trim Fabric G strips to 3 1/2" x 60 1/2" for the side borders.

.....
Sew the Fabric G side borders to the sides of the quilt. Press toward border.

Sew the Fabric F top and bottom borders to the top and bottom of the quilt. Press toward border.

Finishing:

Quilt and bind as desired.

FULL SWING QUILT PATTERN

Designed exclusively for Fat Quarter Shop
by Rachel Griffith (www.psiquilt.com)
Finished Size: 66" x 66"
www.FatQuarterShop.com

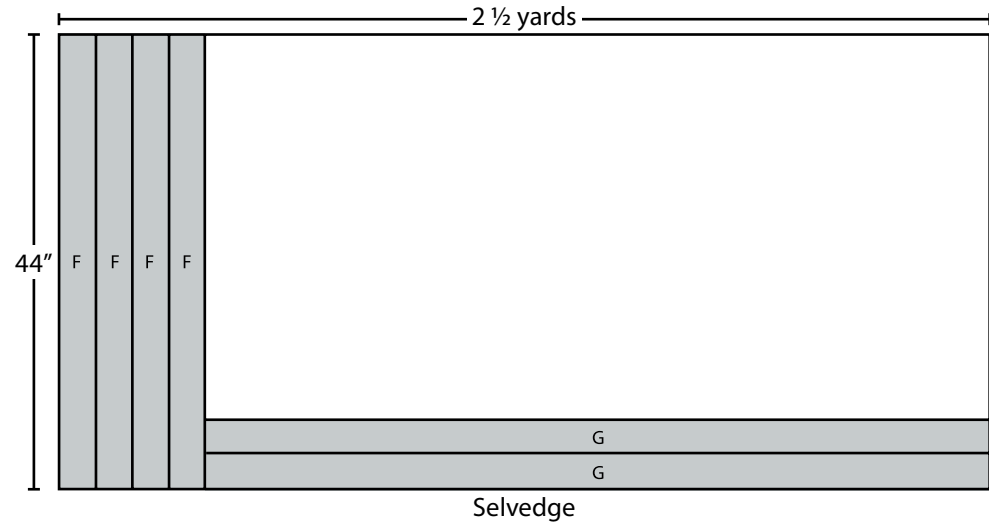

FULL SWING QUILT PATTERN

Designed exclusively for Fat Quarter Shop
by Rachel Griffith (www.psiquilt.com)
Finished Size: 66" x 66"
www.FatQuarterShop.com

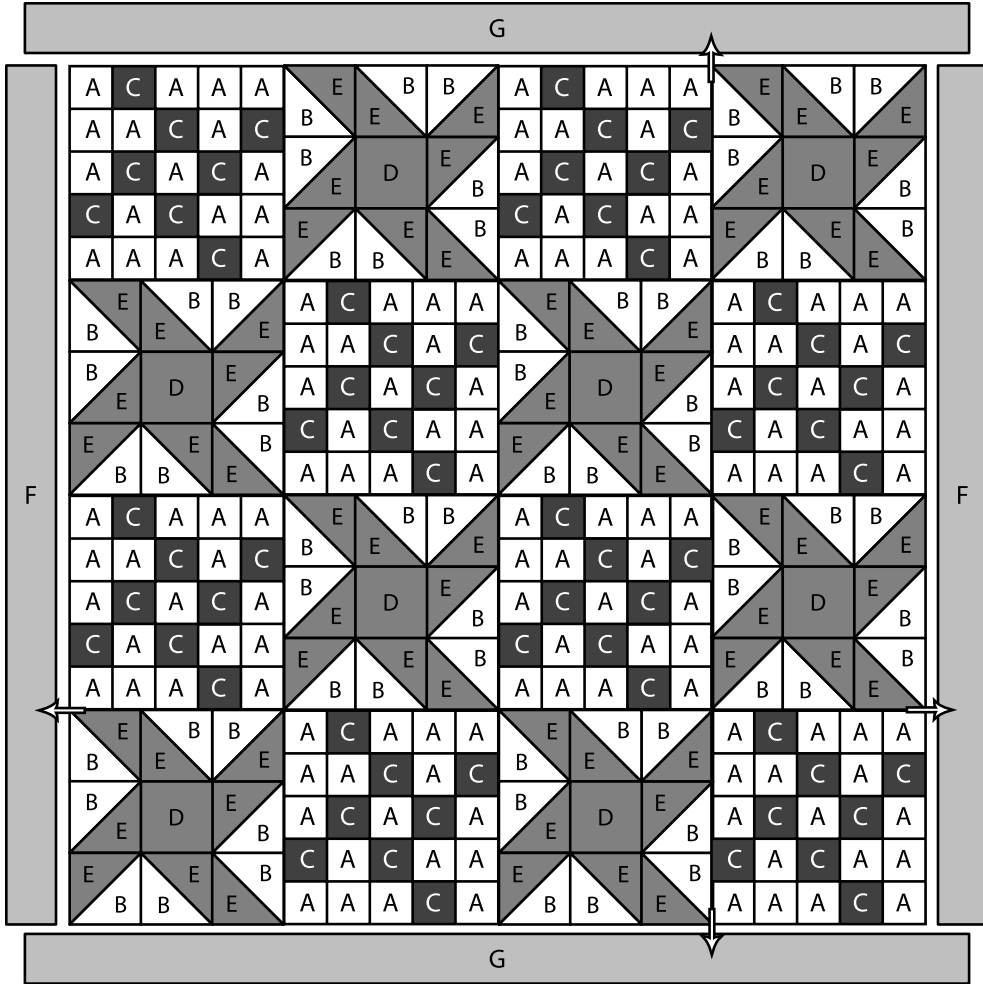

This pattern may be used for personal purposes only and may not be reproduced or distributed without the express permission of Fat Quarter Shop. This pattern may not be used for commercial purposes. All patterns, unless otherwise attributed, are © Fat Quarter Shop 2010. Fat Quarter Shop is the only quilt shop with permission to sell this pattern. All rights reserved. www.FatQuarterShop.com

FULL SWING QUILT PATTERN

Designed exclusively for Fat Quarter Shop
by Rachel Griffith (www.psiquilt.com)
Finished Size: 66" x 66"
www.FatQuarterShop.com

Notes:

This pattern may be used for personal purposes only and may not be reproduced or distributed without the express permission of Fat Quarter Shop. This pattern may not be used for commercial purposes. All patterns, unless otherwise attributed, are © Fat Quarter Shop 2010. Fat Quarter Shop is the only quilt shop with permission to sell this pattern. All rights reserved. www.FatQuarterShop.com

FULL SWING QUILT PATTERN

Designed exclusively for **Fat Quarter Shop**
by **Rachel Griffith (www.psiquilt.com)**

Finish Size: 66" x 66"
www.FatQuarterShop.com

Supplies:

Fabrics: Most fabrics are from Moda's - *Botany* line.

(We do not recommend pre-washing the fabrics used in the pattern.)

9918-11 Muslin Mate Basic White Vines 2 ½ yards



25020-PP Botany Charm Pack 2 Charm Packs

from
Charm Pack

25023-13 Grass Buds 1 ½ yards



25029-18 Cloud Topiary 2 ½ yards



25023-15 Ripple Buds ¾ yard



25028-13 Backing (not included in kit) 4 ½ yards



This pattern may be used for personal purposes only and may not be reproduced or distributed without the express permission of Fat Quarter Shop. This pattern may not be used for commercial purposes. All patterns, unless otherwise attributed, are © Fat Quarter Shop 2009. Fat Quarter Shop is the only quilt shop with permission to sell this pattern. All rights reserved. www.FatQuarterShop.com